



A-dec® 351 Assistant's Instrumentation on an A-dec 311/411/511 Dental Chair

INSTALLATION GUIDE

Contents

Before You Begin 2
Install the Rigid Arm 3
Connect the Wires and Data Line 6
Connect the Tubing and Utilities 10
Test the System 19
Regulatory Information and Warranty 20

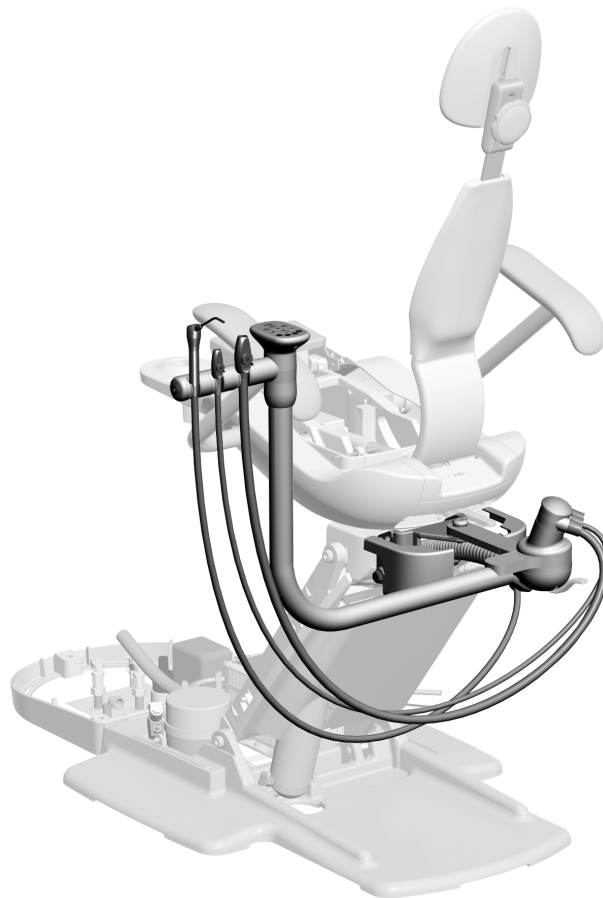

A-dec 351 Assistant's Instrumentation on an A-dec 311B Dental Chair

Product Models and Versions Covered in This Document *

Models	Versions	Description
351	B	Assistant's Instrumentation
311	B	Dental Chair
311ft	n/a	Dental Chair
411	A	Dental Chair
511	A/B	Dental Chair

**Some product models, versions, and options in this document may not be available in certain regions.*

Before You Begin

Recommended Tools

- 3/4" socket and ratchet
- Level
- Mallet
- Hex key set
- Diagonal cutters
- 3/4" combination wrenches (2)
- Wire stripper
- Sleeve pusher



WARNING Shock hazard. When you remove or replace the covers, take care not to damage any wiring or tubing. Verify that the covers are secure after you replace them.

Prepare the Chair

Task 1.



ATTENTION Circuit boards are sensitive to static electricity. Electrostatic Discharge (ESD) precautions are required when touching a circuit board or making connections to or from the circuit board. Circuit boards should be installed only by an electrician or qualified service person.

- 1** Fully raise the chair base and back. Set the jumper on the circuit board to BASE UP and BACK UP, if necessary.



WARNING Failure to turn off or disconnect the power before you begin this procedure can lead to product damage and result in serious injury or death.

- 2** Turn off the power to the system.

Install the Rigid Arm

Task 1.

- 1** Slide the bearing and two flat washers from the kit onto the screw.
- 2** Insert the screw through the hole in the assistant's instrumentation arm.
- 3** Slide the Nylatron® washer onto the screw.

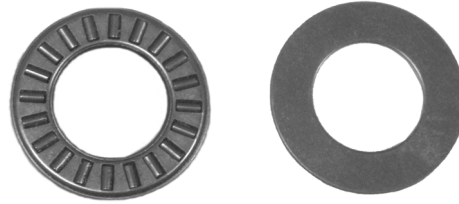

Bearing

Flat Washer

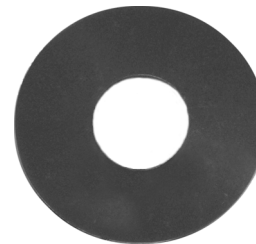

Nylatron Washer

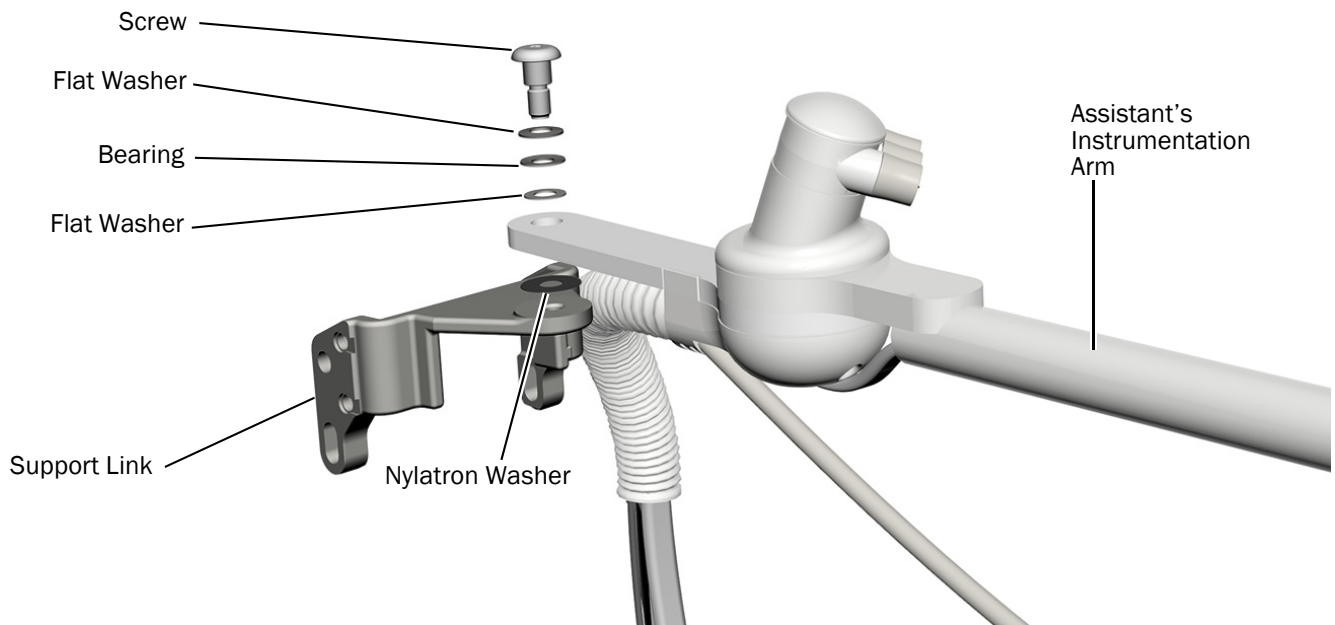

- 4** Put Loctite® 242™ on the end of the screw.

- 5** Use a 1/4" hex key to securely tighten the arm to the support link.

Task 2.

- 1** Get four bolts and washers from the kit.
- 2** Pick up the assistant's instrumentation arm assembly and align the holes in the support link with the holes in the chair frame.

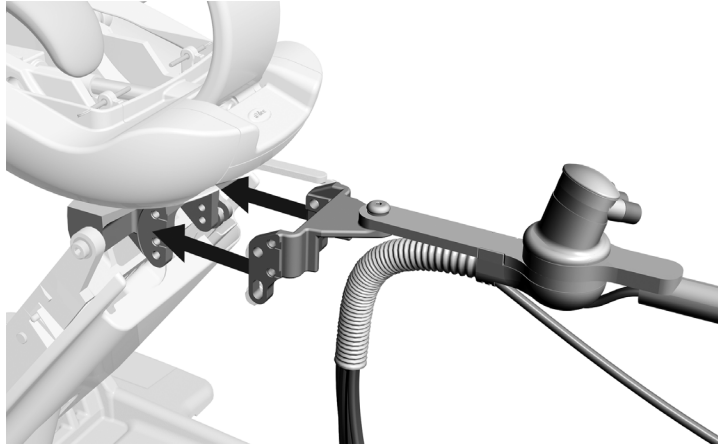

- 3** Attach the support link to the chair with the four bolts and flat washers.



Task 3.

- 1** Place the syringe in its holder on the assistant's instrumentation.
- 2** Place the high volume evacuator (HVE) and saliva ejector in their holders; then attach their tubing to the vacuum canister.

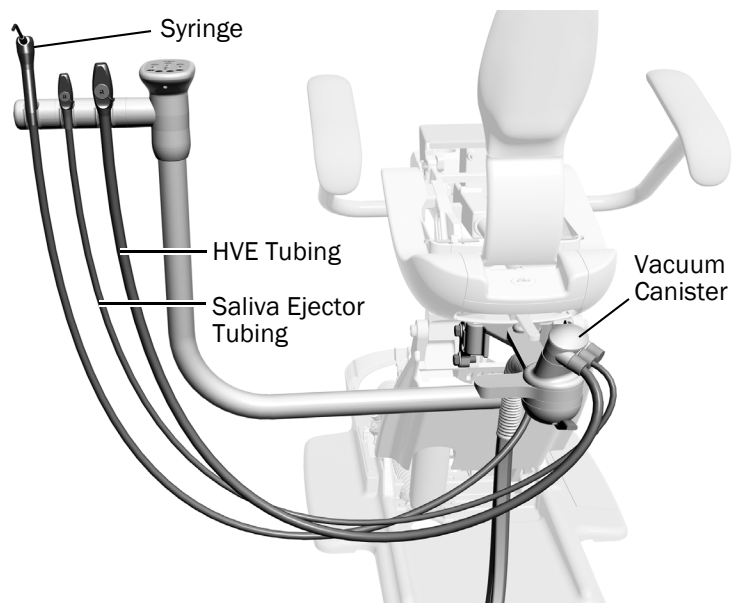

Task 4.

- 1** From the back of the chair, route the vacuum line, power cable, syringe tubing, and data line underneath the support link and through the opening at the top of the lift arm.
- 2** Route the vacuum line, power cable, syringe tubing, and data line down the lift arm and into the floor box.



NOTE Leave the syringe tubing unconnected. It will be connected later in the installation.

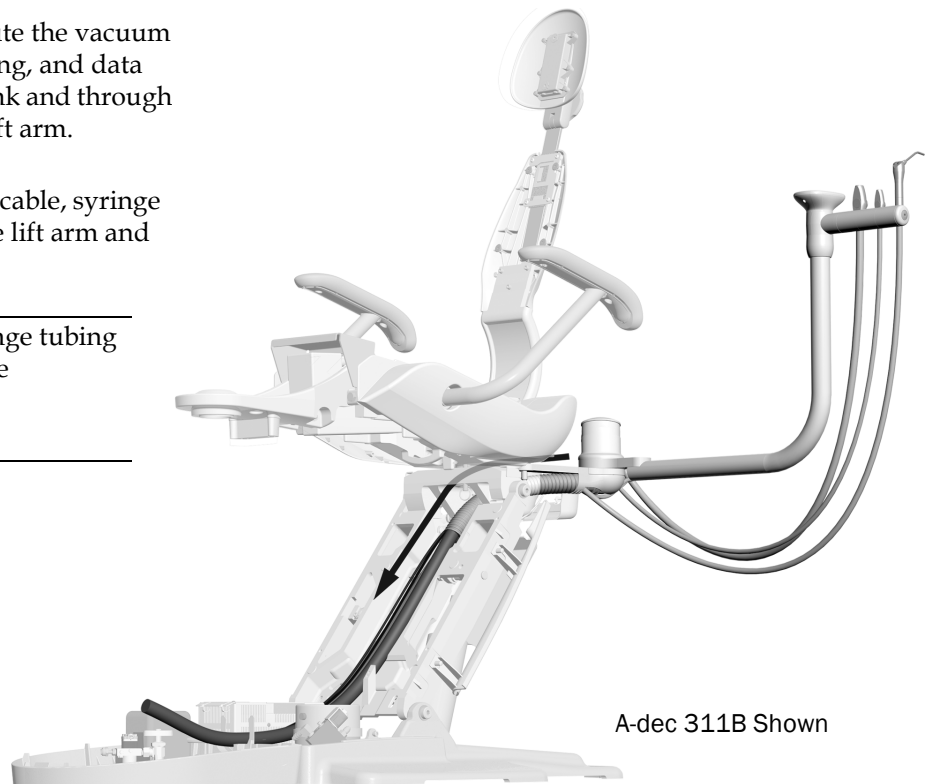

A-dec 311B Shown

Connect the Wires and Data Line



ATTENTION Circuit boards are sensitive to static electricity. Electrostatic Discharge (ESD) precautions are required when touching a circuit board or making connections to or from the circuit board. Circuit boards should be installed only by an electrician or qualified service person.



WARNING Failure to turn off or disconnect the power before you begin this procedure can lead to product damage and result in serious injury or death.



CAUTION To avoid damaging or disconnecting wires and tubing, don't connect anything until all of the system's modules are installed.



NOTE The top of the power supply has a diagram of the electrical connections for the chair circuit board.

1. Turn off the power to the chair.

Complete the section according to which power supply the system includes.

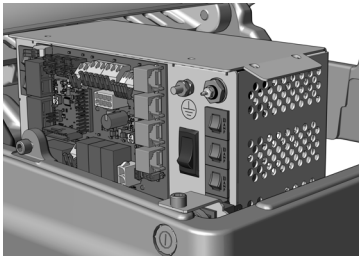

Connect the Wires and Data Line on an A-dec Universal Power Supply Manufactured After 20237

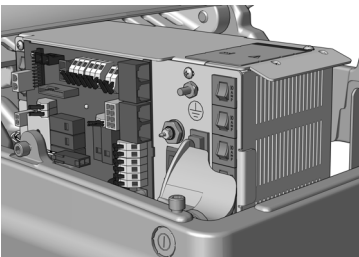

Connect the Wires and Data Line on an A-dec 311/411 Power Supply Manufactured Before June 20238

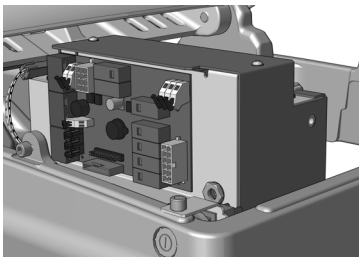

Connect the Wires and Data Line on A-dec 511 Power Supply Manufactured Before June 20239

Connect the Wires and Data Line on an A-dec Universal Power Supply Manufactured After 2023

1. Connect the black wire from the assistant's system cable to the 0 V wire connector.
2. Connect the gray wire from the assistant's system cable to the 24 V wire connector.



CAUTION Plugging the black DCS1 data line into a DCS2 port can damage the product.

3. Plug the black DSC1 data line into any port on the head side of the chair.
4. Use cable ties to secure the assistant's system cable under the lip on the power supply.

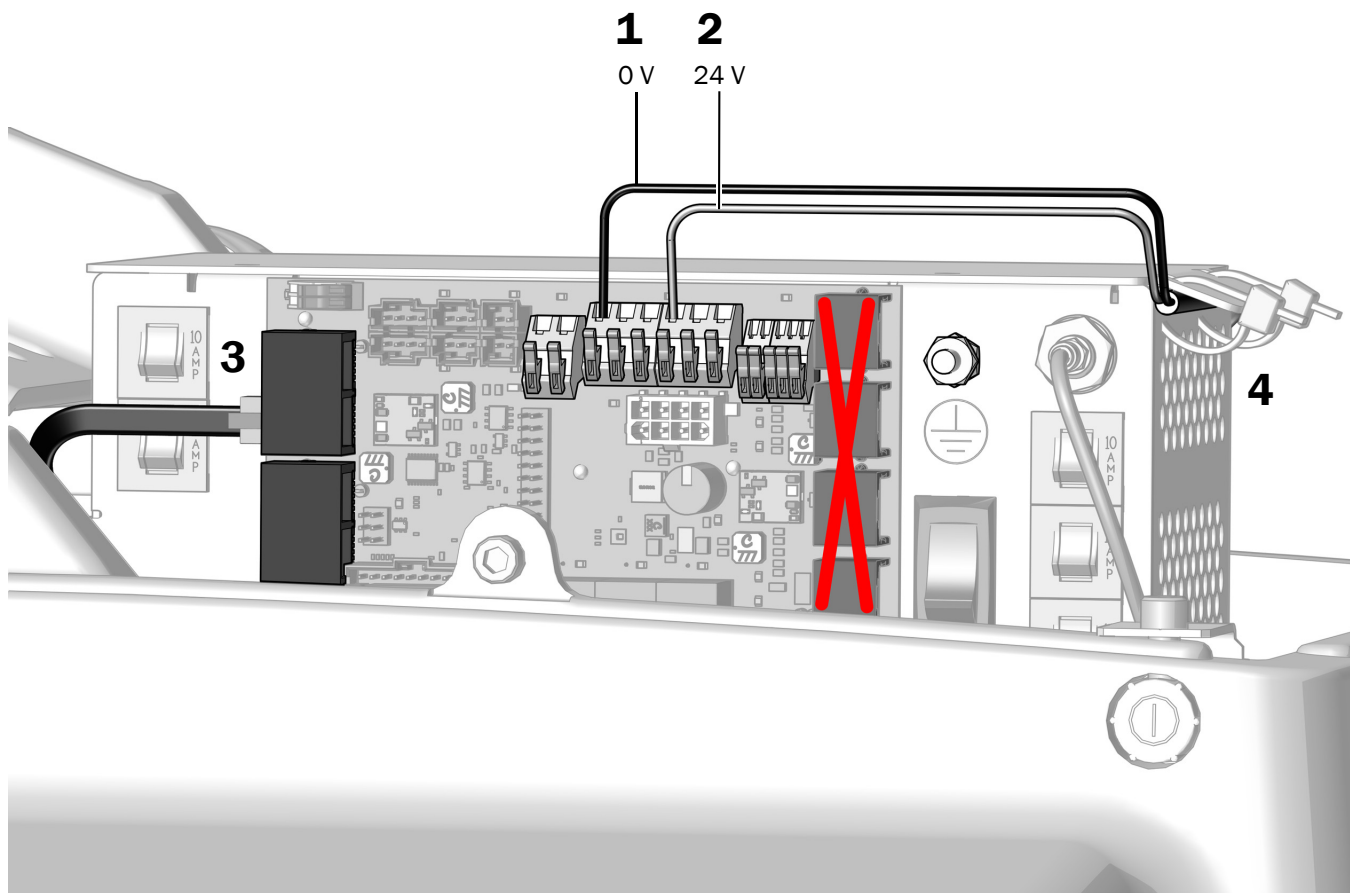

Next Step See "Connect the Tubing and Utilities" on page 10.

Connect the Wires and Data Line on an A-dec 311/411 Power Supply Manufactured Before June 2023

1. Connect the black wire to 0 VAC.
2. Connect the gray wire to 24 VAC.



NOTE If needed, you can connect more than one wire to a single terminal.

3. Plug the data line into any data port.
4. When all modules have been connected to the power supply, secure the wires under the lip on the power supply.

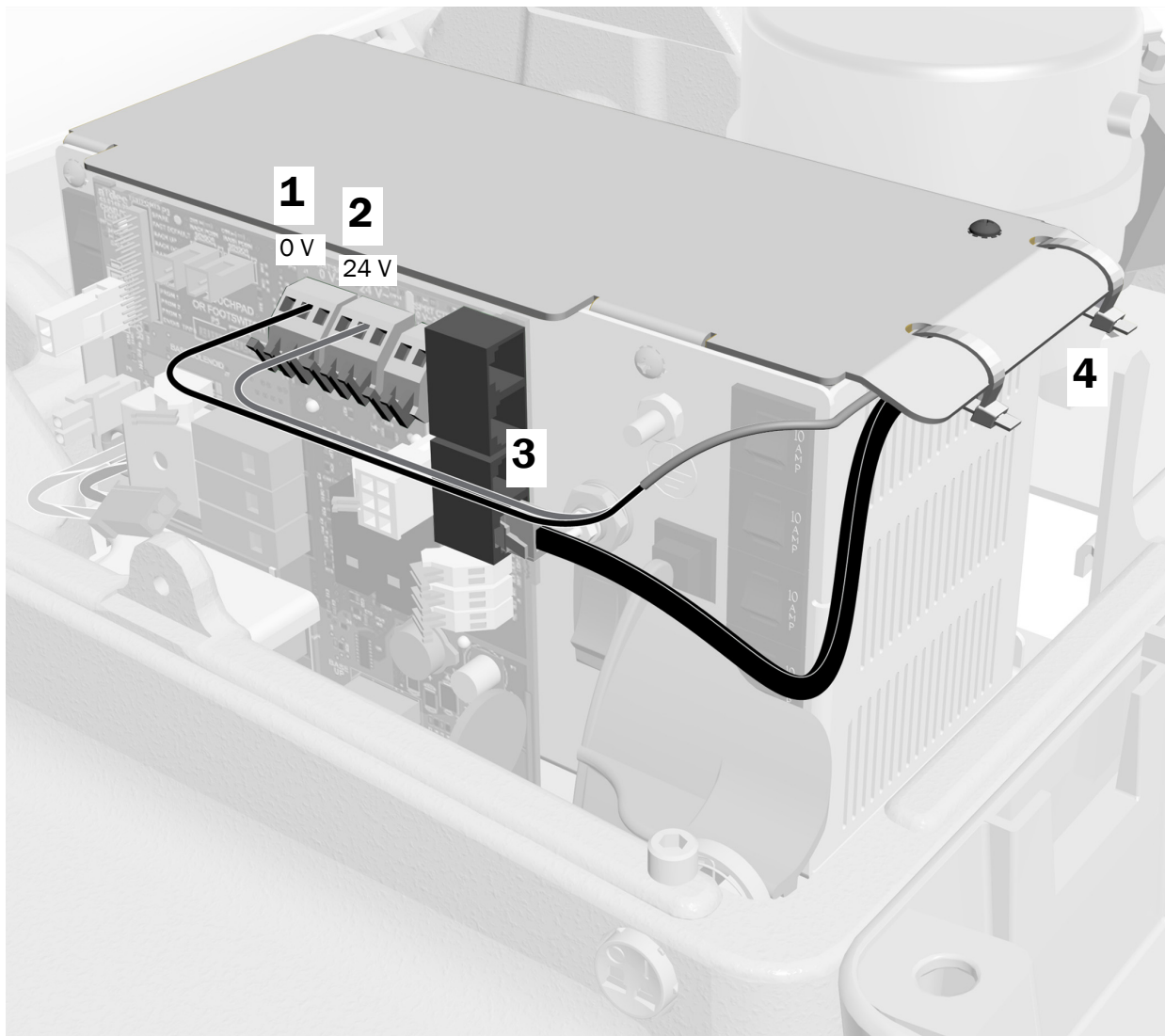

Next Step See "Connect the Tubing and Utilities" on page 10.

Connect the Wires and Data Line on A-dec 511 Power Supply Manufactured Before June 2023

Recommended Tools

- Phillips head screwdriver
 - Diagonal cutters
1. Plug the data line into any data port.
 2. Connect the black wire to 0 V.
 3. Connect the gray wire to 24V.
 4. Secure the power cable to the bail with a cable tie.

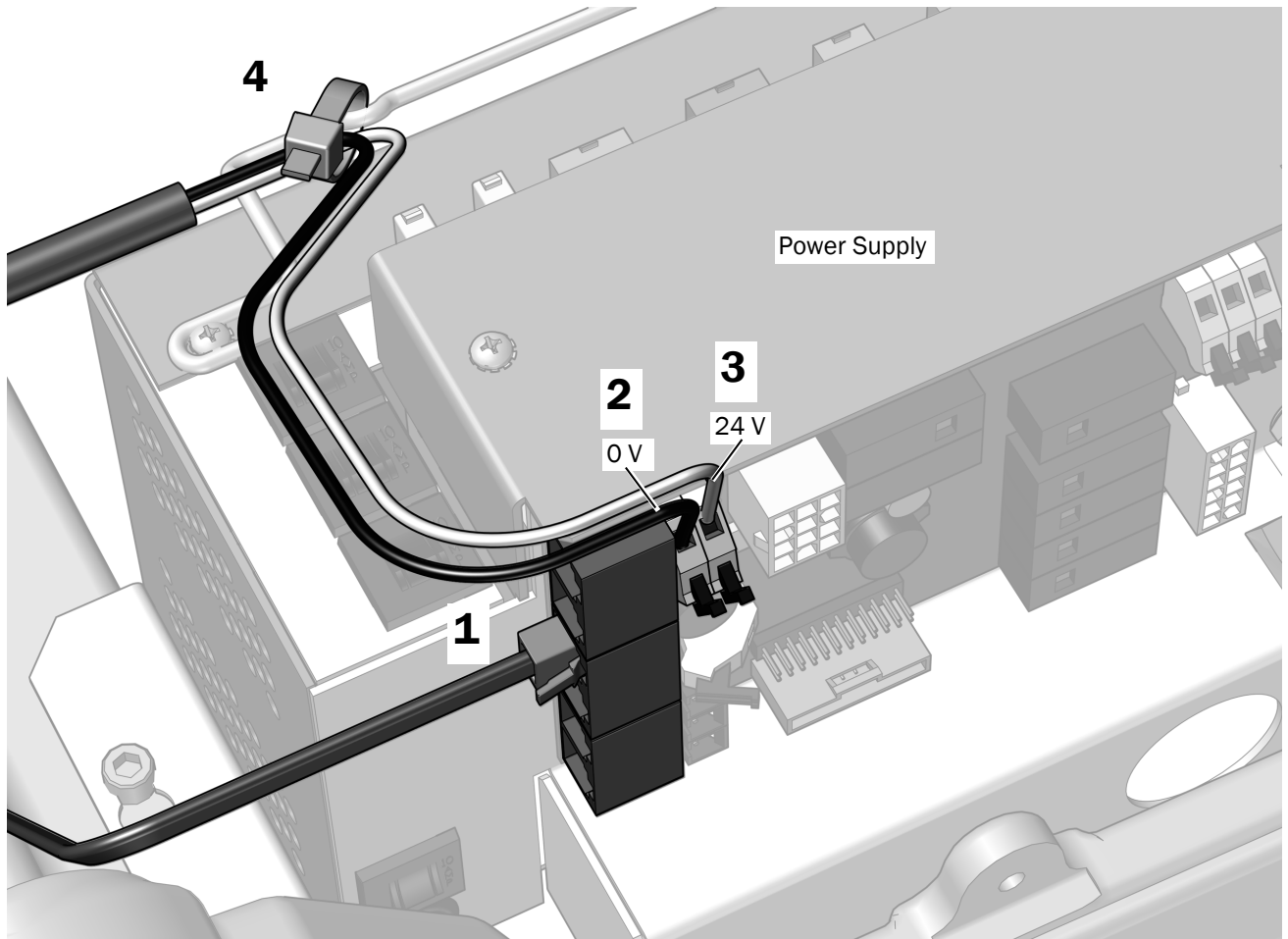

Connect the Tubing and Utilities



CAUTION To avoid damaging or disconnecting wires and tubing, don't connect anything until all of the system's modules are installed.

Recommended Tools

- Diagonal cutters
- Sleeve pusher

Complete the connections for the system's configuration.

For Assistant's Instrumentation Only

Connect the Tubing for an Assistant's Instrumentation Only	11
Connect the Utilities for an Assistant's Instrumentation Only	12

For Systems that include an A-dec 300 Delivery System

Connect the Tubing for a System with that Includes an A-dec 300 Delivery System	13
Connect the Utilities for a System that Includes an A-dec 300 Delivery System	15

For Systems that include an A-dec 500 Delivery System

Connect the Tubing for a System that Includes an A-dec 500 Delivery System	16
Connect the Utilities for a System that Includes an A-dec 500 Delivery System and a 500 Manifold	18

Connect the Tubing for an Assistant's Instrumentation Only

Use this diagram if the system does not include any other modules except an assistant's instrumentation.



NOTE When installing the water manifold, be sure to connect to the barb on the end to prevent standing water in the manifold.



CAUTION Do not connect the white or blue tubing.

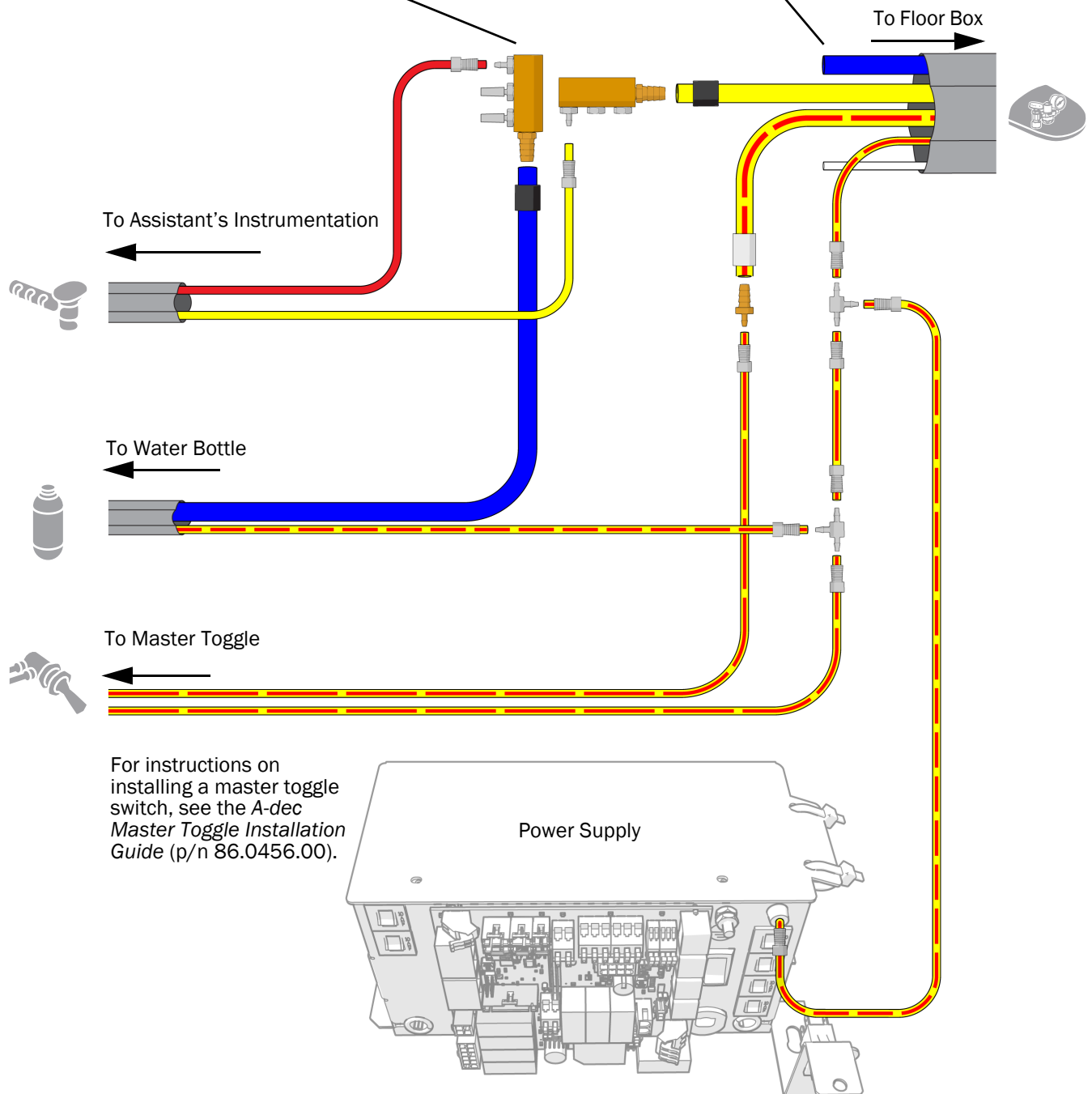

Connect the Utilities for an Assistant's Instrumentation Only

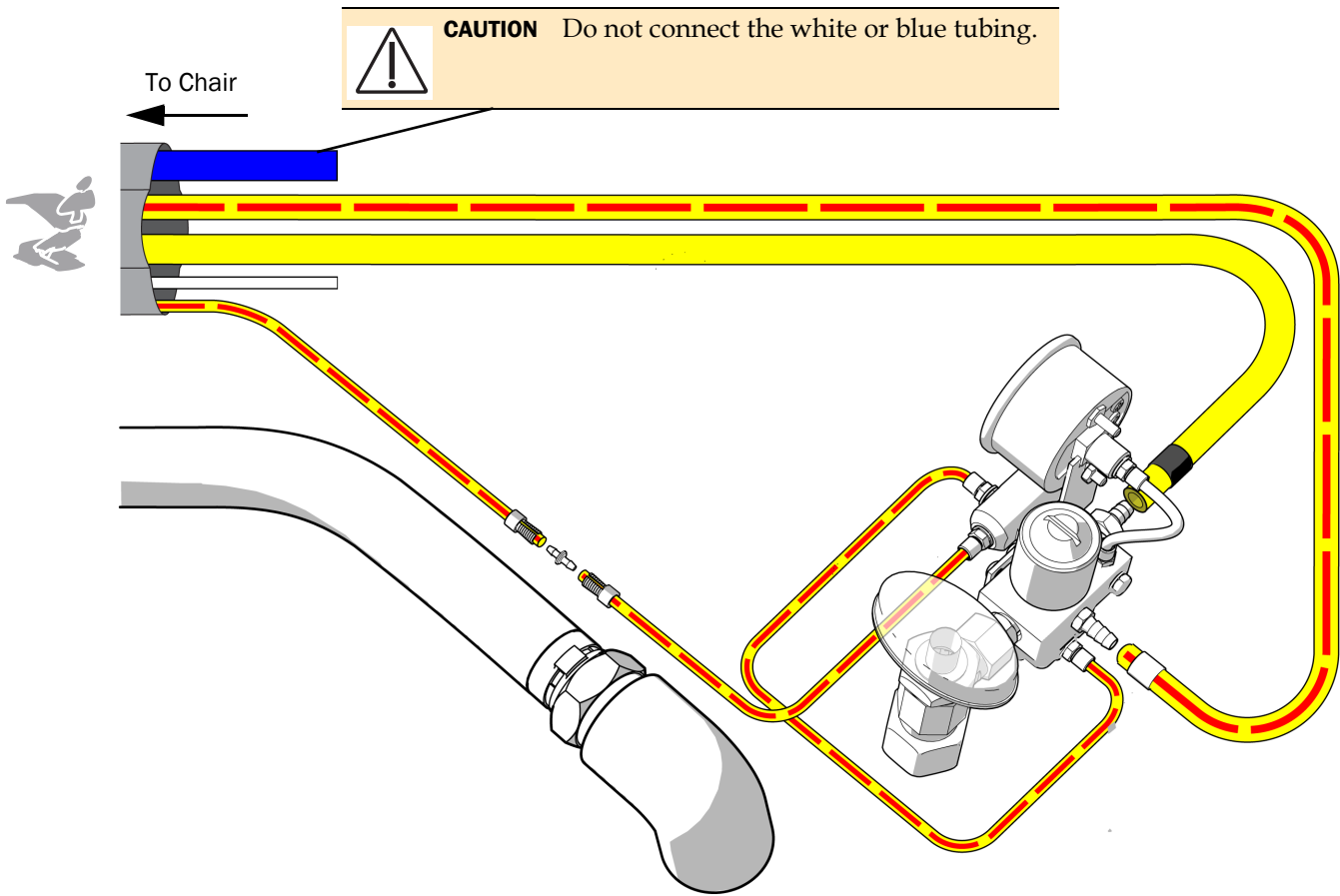

Next Step See "Test the System" on page 19.

Connect the Tubing for a System with that Includes an A-dec 300 Delivery System

1. If the system includes a delivery system, strip and remove three feet of the sheath from around the water bottle tubing.
2. Connect the tubing according to the flow diagram on page 14.



NOTE When installing the water manifold, be sure to connect to the barb on the end to prevent standing water in the manifold.

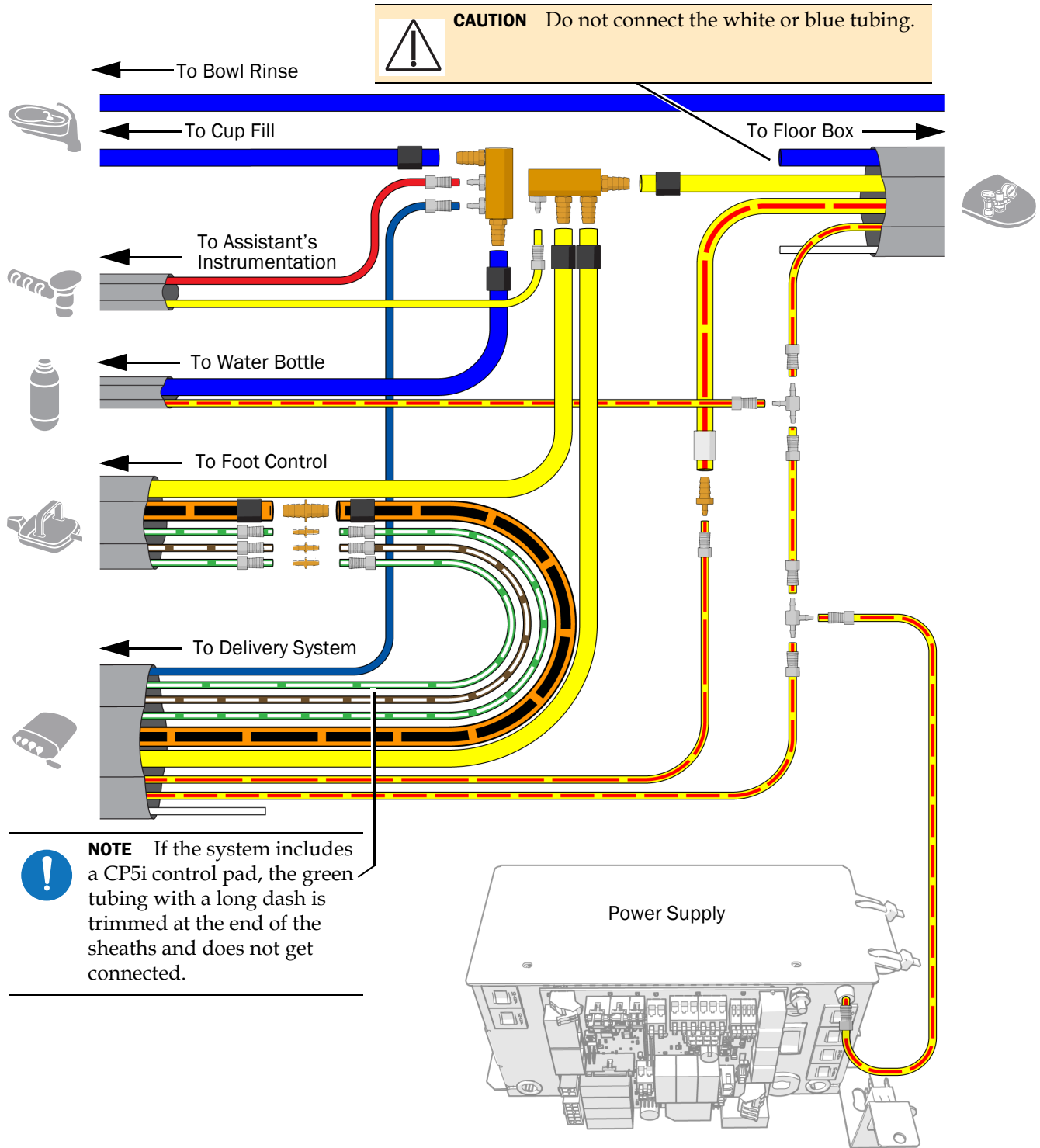

Connect the Utilities for a System that Includes an A-dec 300 Delivery System

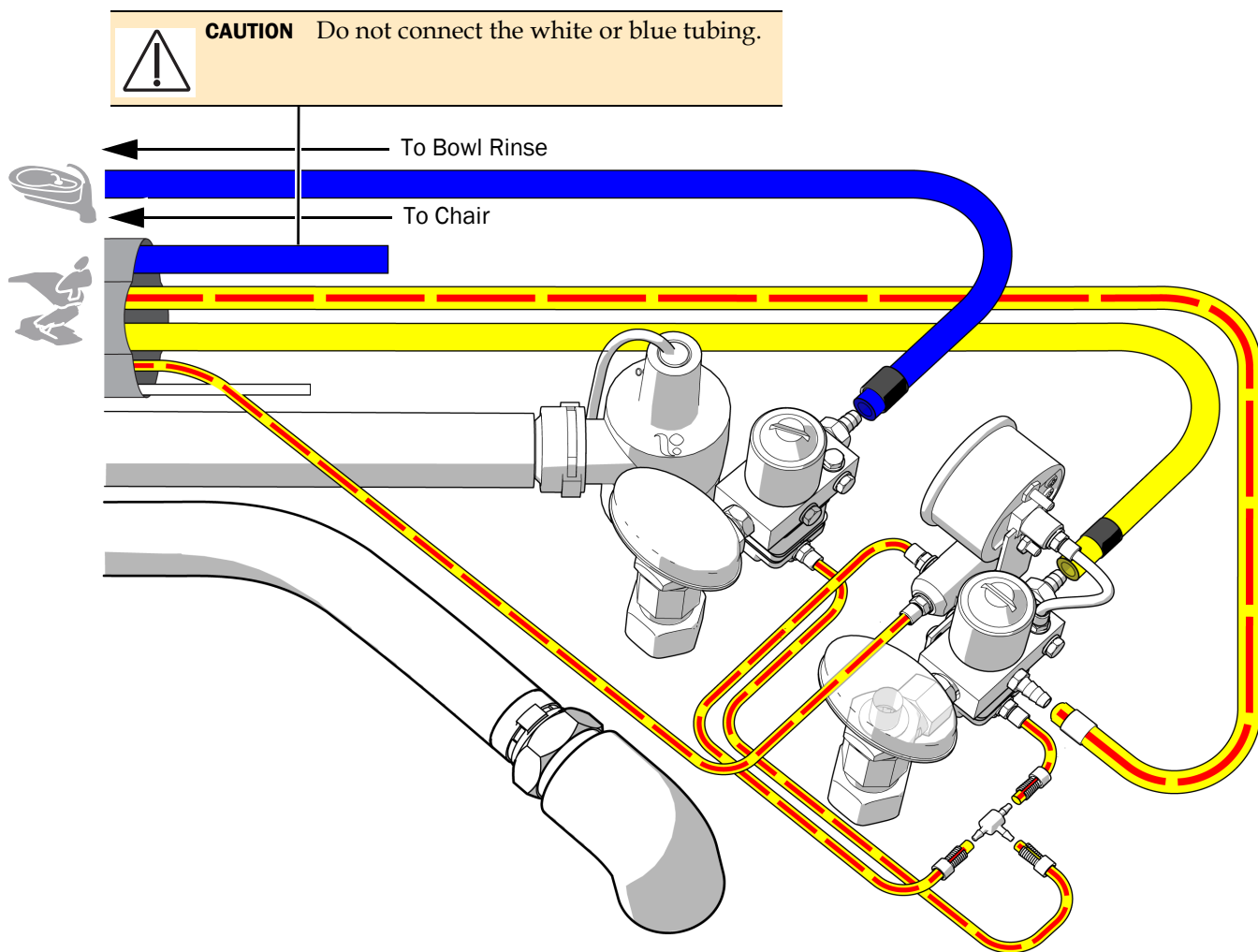

Next Step See "Test the System" on page 19.

Connect the Tubing for a System that Includes an A-dec 500 Delivery System

Prepare and Connect the Tubing

Recommended Tools

- Diagonal cutters
- Sleeve pusher

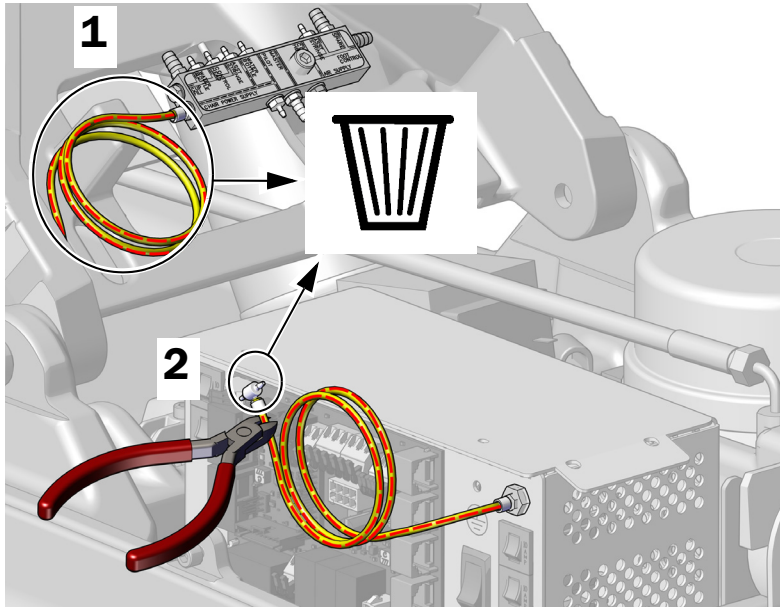

1 Remove and discard the air tubing from the manifold.

2 Remove and discard the tee from the air tubing connected to the power supply.

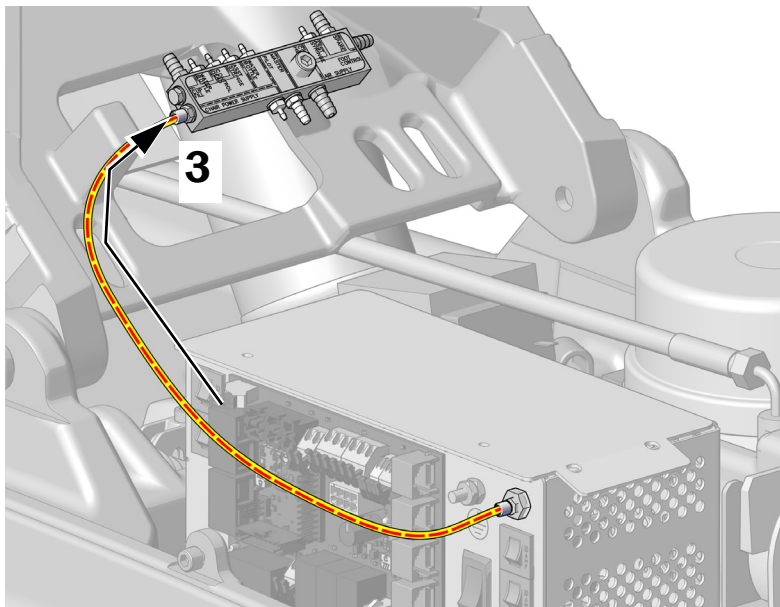

3 Use a sleeve and sleeve pusher to connect the tubing from the power supply to the manifold.

4 Strip and remove 3 feet (914 mm) of the sheath from around the water bottle tubing.

5 Connect tubing for all modules according to the flow diagram on the following page.

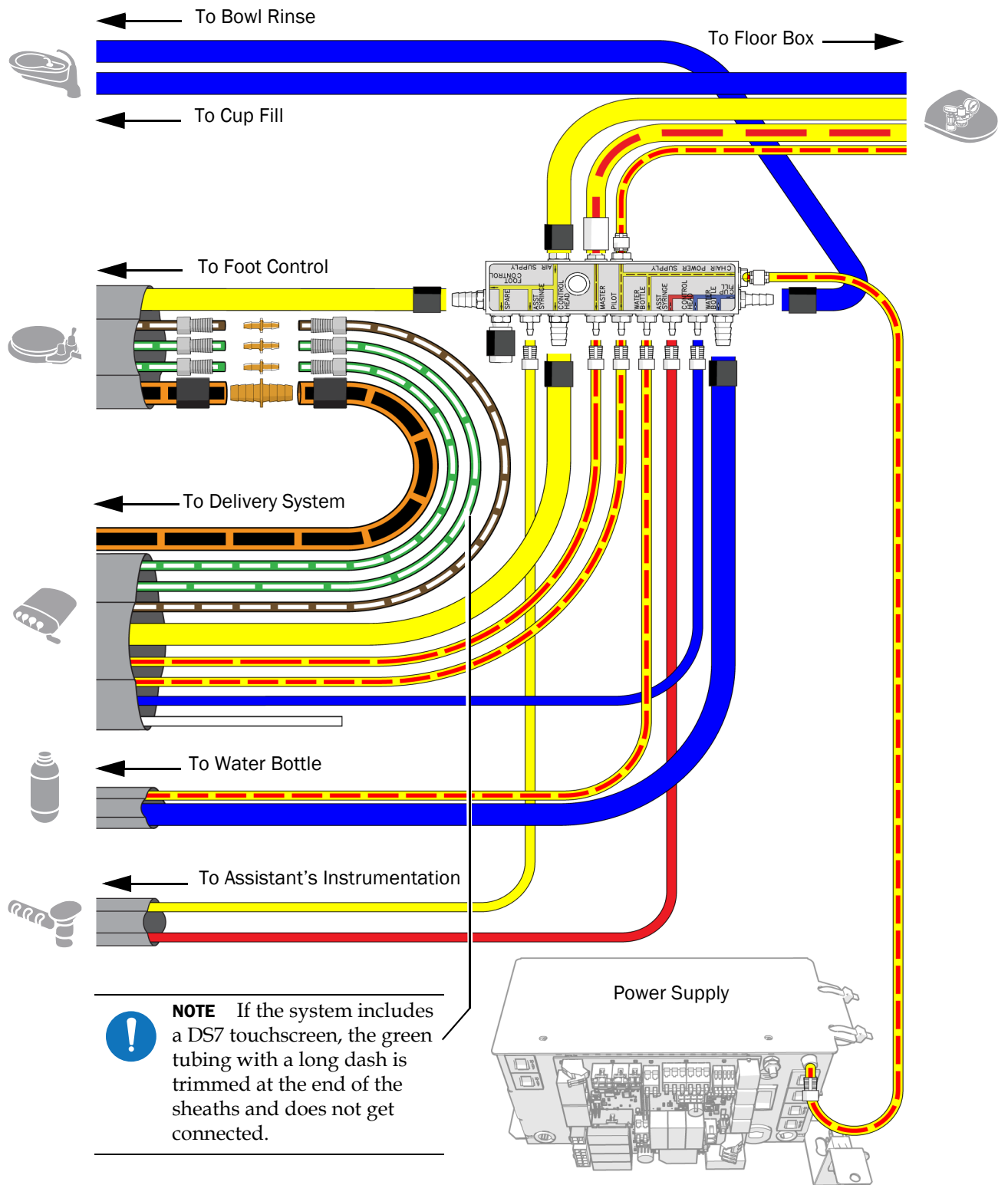

Connect the Utilities for a System that Includes an A-dec 500 Delivery System and a 500 Manifold

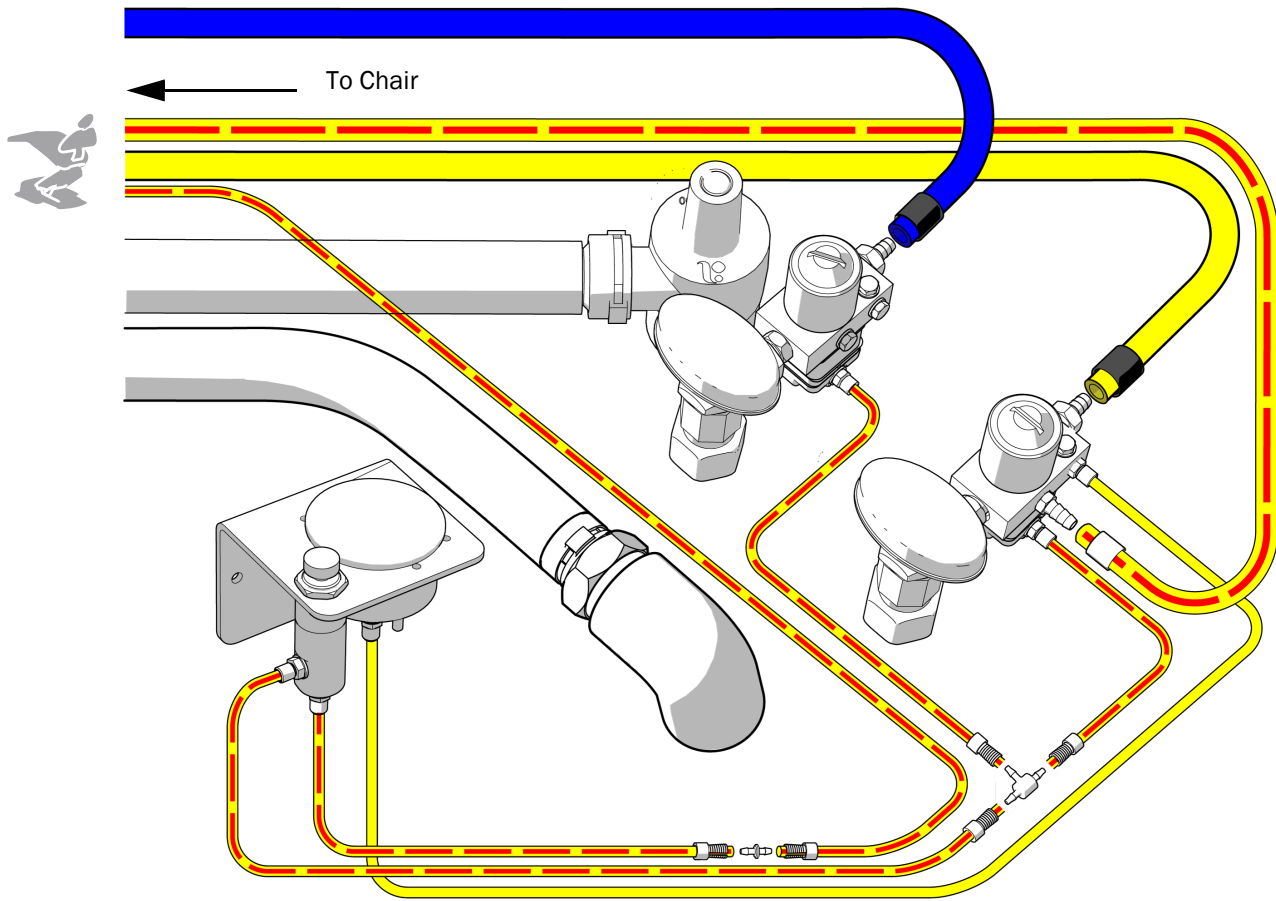

Test the System

After you have completed the installation, use the following checklist to test the system; then follow up with the customer.

- Regulated air pressure is a 80 psi (552 kPa).
- Vacuum/suction is set to the following specifications:
 - **Wet vacuum** - 10 ± 2 inches of Hg (34 ± 7 KPa), 9 SCFM (255 sl/min) minimum
 - **Dry/semi-dry vacuum** - 4.5 ± 1 inches of Hg (16 ± 3.5 KPa), 12 SCFM (340 sl/min) minimum
- Floor box is free of air and water leaks.
- The gravity drain is functioning properly.
- Tubing and connections are not kinked and are free of air and water leaks.
- Tubing and wires are coiled and stored away from moving parts.
- Syringe, saliva ejector, and high volume evacuator function properly.
- Touchpad functions properly.

Regulatory Information and Warranty

For required regulatory information and the A-dec warranty, see the *Regulatory Information, Specifications, and Warranty* document (p/n 86.0221.00) available in the Resource Center at www.a-dec.com.



For quick access to this document online, scan, tap, or click this QR code, which points to a-dec.com/regulatory-guide.

Loctite and Loctite 242 are trademarks or registered trademarks of Henkel IP & Holding GmbH in the United States and may be trademarks or registered trademarks in other countries. All other trademarks cited herein are registered trademarks or trademarks of A-dec, Inc. in the United States and may also be trademarks or registered trademarks in other countries.



A-dec Headquarters

2601 Crestview Drive
Newberg, OR 97132 USA
Tel: 1.800.547.1883 Within USA/CAN
Tel: +1.503.538.7478 Outside USA/CAN
www.a-dec.com

A-dec, Inc. makes no warranty of any kind with regard to the content in this document including, but not limited to, the implied warranties of merchantability and fitness for a particular purpose.



86.0569.00 Rev G
Date of Issue 2023-10-16
Copyright 2023 A-dec, Inc.
All rights reserved.
IGrphpor22